

MILESTONE HUSKY™ M550A

10GbE NVR Hardware Platform with Scalable VMS Software



Introducing Husky M550 Advanced milestone



Highest Performance 2U Windows
10Gbe NVR in the industry



- 10GbE Converged Network
- 1400Mb/s Recording Rate
- Unlimited Storage
- Redundant Power Supply

Milestone Advanced NVR's Have....

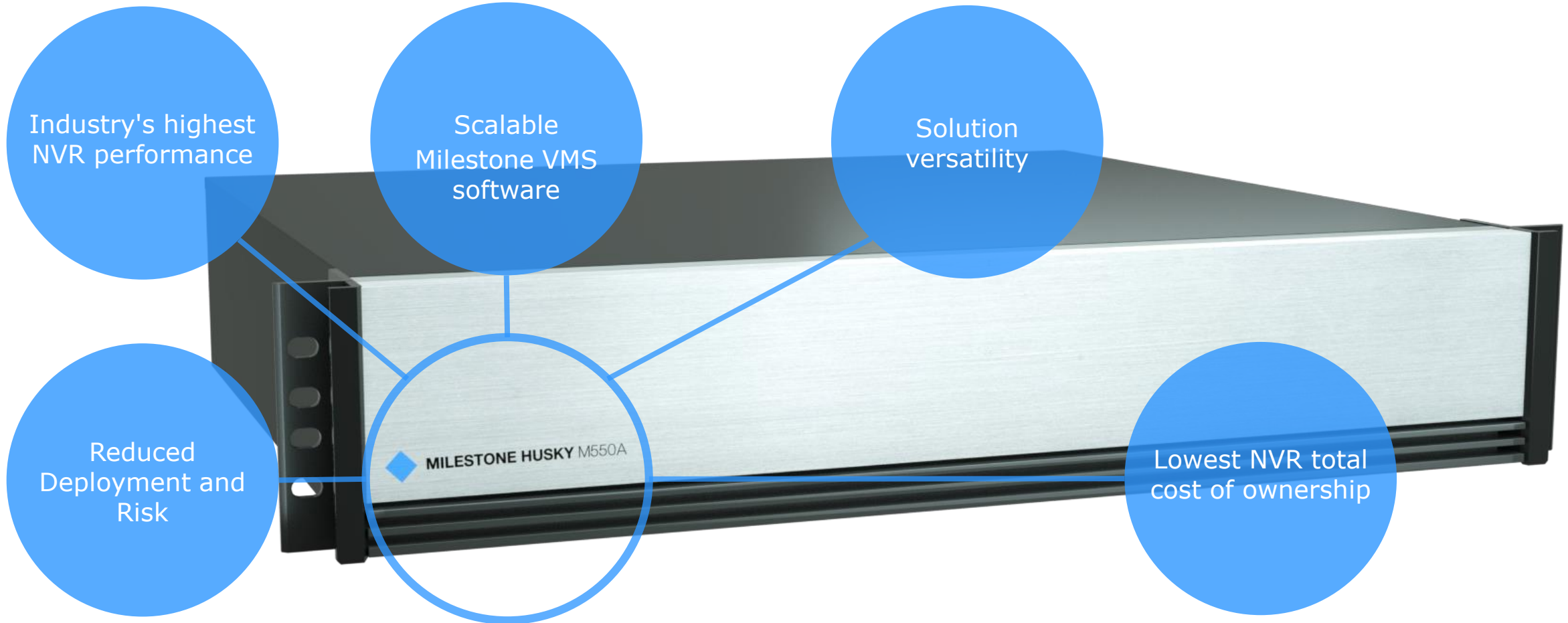

New M550A Compared to M500A

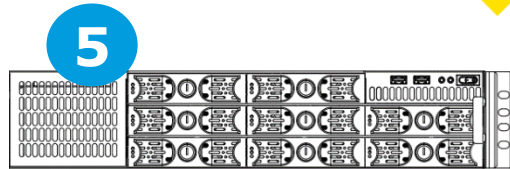
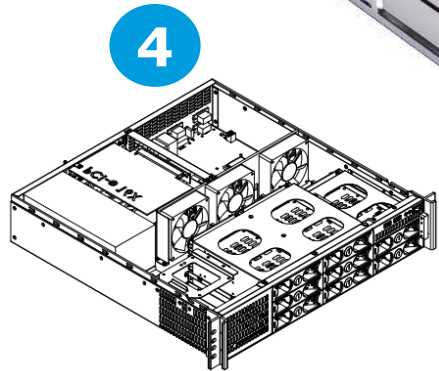
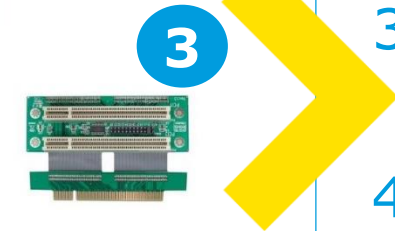

1. New 10Gbe + Storage HBA
 - Intel Ethernet Converged Network Adapter X550T2
2. New Redundant, Dual 1+1 Power Supply
3. New PCI Express 3.0 and 2x8 Riser
4. New 2U Chassis Design and Dimensions
5. New HDD Bay Layout
6. New 8TB Drives with up to 64TB Internal Storage Capacity



Top features



Intel Ethernet Converged Network Adapter X550T2

- Simplified 10 GbE support
 - 100 / 1000 / 10G BASE-T support
 - Standard CAT 6 / 6a cabling and RJ45 connectors
- Unified Network
 - LAN, iSCSI and FCoE on a single interface/chip/wire
 - Converging data and storage onto one interface
- Low Power
- Unlimited External Storage Capacity



Top features



Enhanced Electronics 2U 1+1 Redundant Power Supply Unit

- 1+1 Redundant Dual Power Supply
 - Hot Swappable
 - Field replacement
- 2U Form Factor
 - Short depth keeps chassis size down
- Reliable 400 Watt Supply
 - MTBF 100,000 hrs

Mechanical System Updates

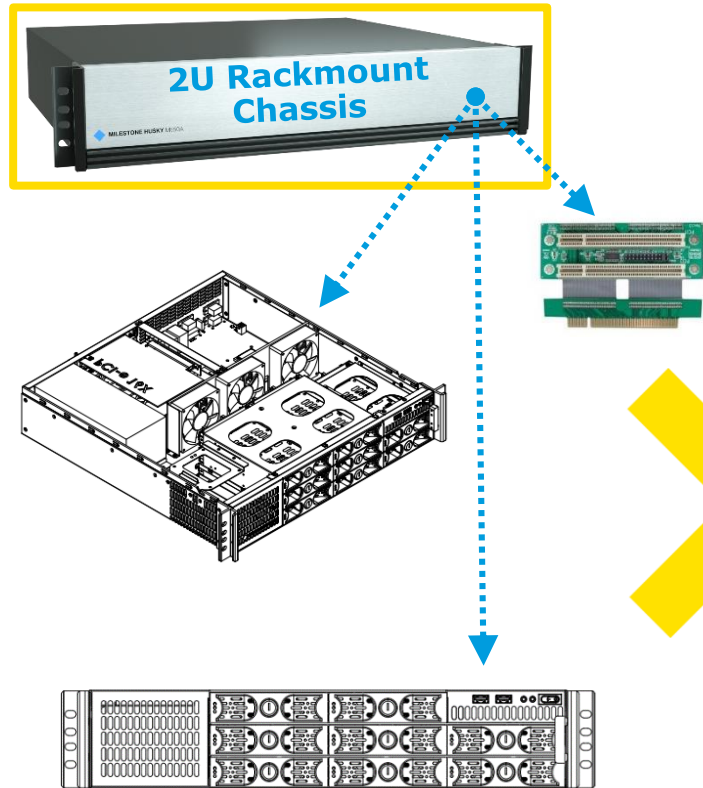

Top features



Updated Chassis, Layout and PCIe Revision and Riser

- New Chassis & Component Layout
 - <5cm increase in depth
 - Upgraded fans and airflow
- PCI Express 3.0 Revision and 2x8 Riser
 - 8.0 GT/s (giga-transfers per second)
- New Hard Drive Bay Layout
 - 8 drives but improved system airflow

Updated Chassis and Layout

Storage System Updates

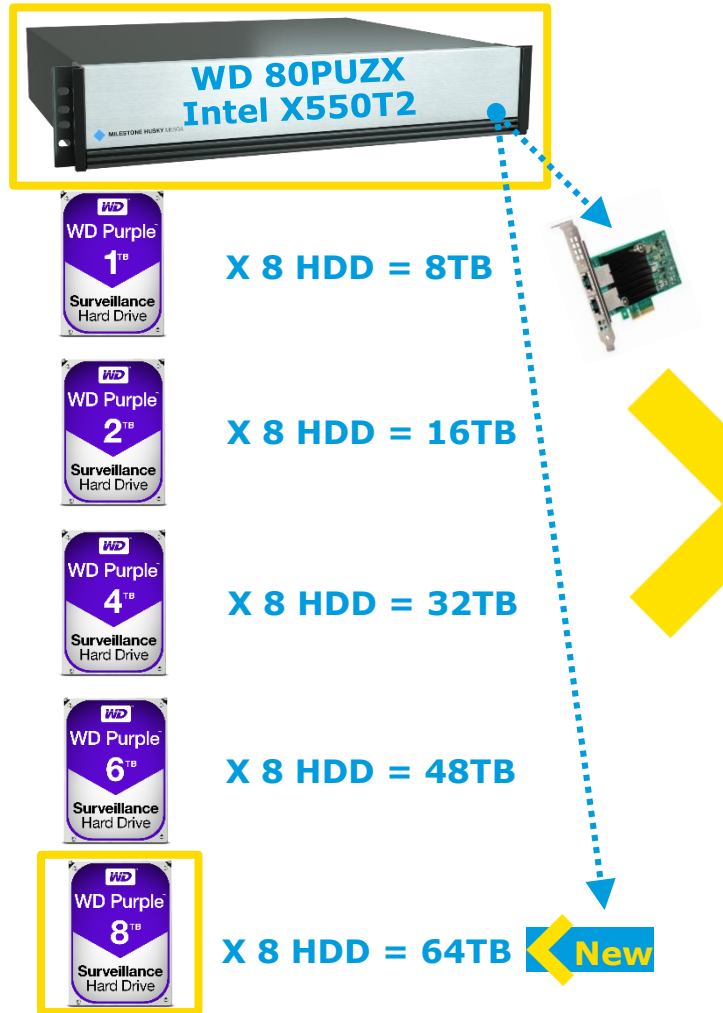

Top features



Western Digital Purple Drives & Intel Storage Host Bus Adapter

- New 8TB HDD's Supported
 - 64TB Sku added - HM550A-XPET-64TB
 - Higher performance 1,424 Mb/s per disk
 - 128 MB Cache per disk
 - Hot Swappable
- Scale Beyond 64TB with External Storage
 - Intel X550T2 Unifies LAN & Storage Protocols
 - Native 3rd Party SAN support using iSCSI and FCoE 1GbE & 10GbE

How To Select Your Husky M5xx?



Top
features



Requirements	M50	M500 Advanced	M550 Advanced
Recording Rate	Up to 544Mb/s	Up to 600Mb/s	Up to 1400Mb/s
NVR Camera Class	80-128 max.	1 to 512	1 to 768
Network	2 x 1GbE	2 x 1GbE	2 x 1GbE, 2 x 10GbE
Internal Video storage	8TB to 48TB	8TB to 64TB	8TB to 64TB
RAID	Optional 5,10	5,6,10,50	5,6,10,50
External Live Database	No	No	iSCSI SAN, FCoE SAN
External Archives	No	NAS	iSCSI SAN, FCoE SAN
Video Management System	XProtect Professional	XProtect Expert or Corporate	XProtect Expert or Corporate
Recorder Failover	No	Yes	Yes
Device License Portability	No	Yes	Yes

Advanced NVR Solution Versatility



Stand-alone
All-in-one Installation
32 to 512+ cameras

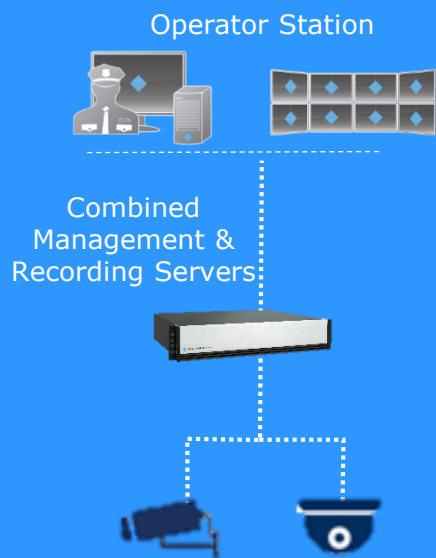

- Pre-installed
- Advanced VMS
- All-in-one Solution

Large Scale
Multi-NVR and NAS Archives
128 to 2048+ cameras

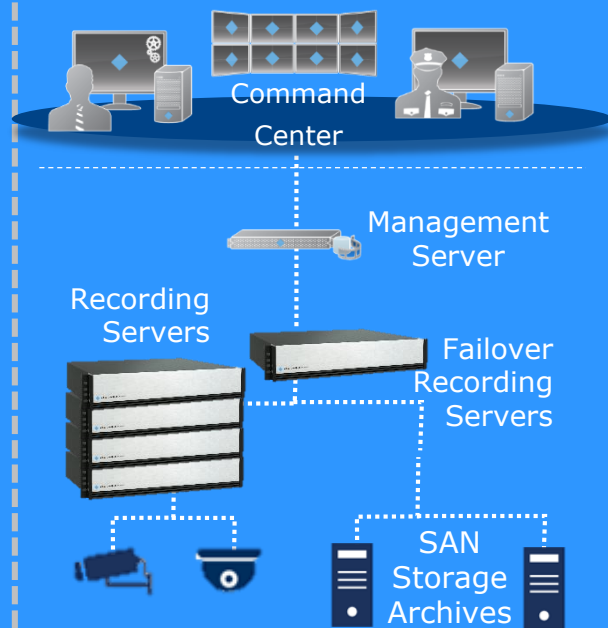

- NVR load balancing
- Failover Recording Servers
- Unlimited External Storage

High Availability
Complex Solutions
512 to 10,000+ cameras

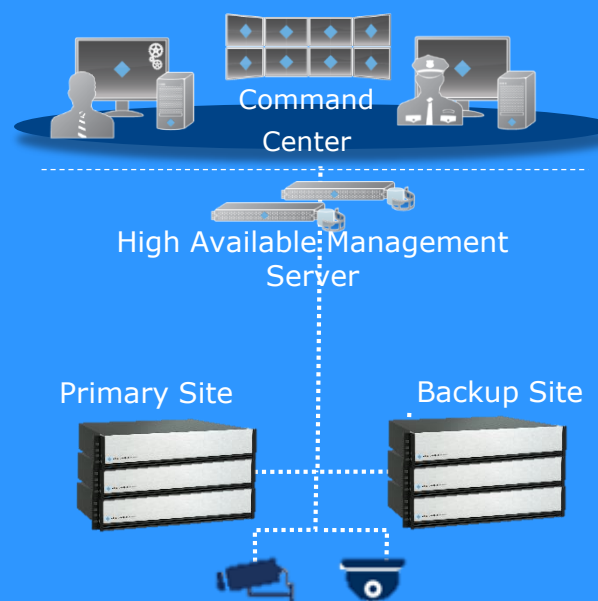

- High Availability Management
- Dual Recorded Video
- Extended Systems Monitoring

Global Operations
Centralized Management
Unlimited sites and cameras

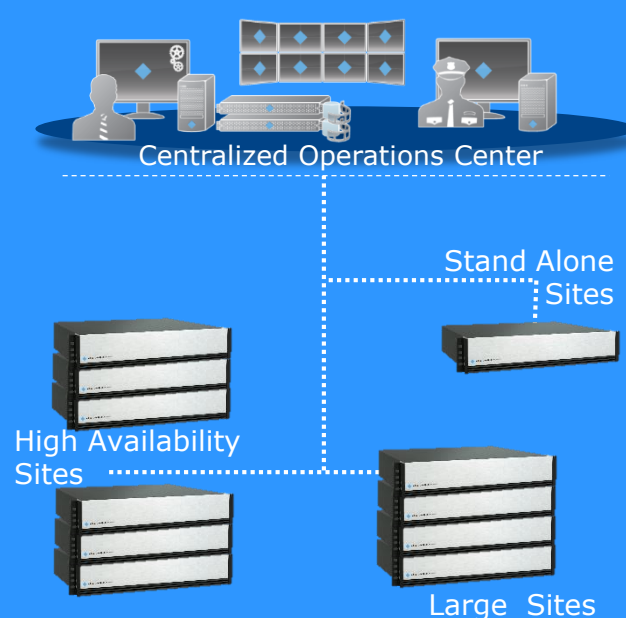

- Federated Architecture
- Interconnected sites
- Centralized Management

From Stand-alone Sites to Global Operations

Solution versatility

Scalable Milestone Advanced VMS



- **Pre-loaded** with:
 - XProtect Expert 2016
 - XProtect Corporate 2016
- **Pre-licensed** for XProtect Expert 2016
- **Updatable** to XProtect Expert 2016 R2
- **Upgradable** to XProtect Corporate 2016 R2
- **Compatible** as recording server with :
 - XProtect Expert
 - XProtect Corporate VMS systems

Unique advantages with XProtect Corporate milestone

In addition to benefits of XProtect Expert, XProtect Corporate offers:

Distributed multi-site surveillance

Span surveillance operation across multiple sites
Minimizes cost at system extensions

Multi-stage video storage

Video grooming – reduce video size for long term storage
Optimize use of network storage – reduced storage cost

Video storage encryption and signing

Prevents internal tempering in high security installations
Enforce e2e video integrity – compliance to regulations

Included XProtect Smart Wall

Fully integrated video wall solution
Reduces response times & increase efficiency

Evidence Lock

Prevent deletion of video during investigations
Reduce cost for case handling - compliance to regulations

Configurable user rights management

Time control user access and tiered management rights
Protects system integrity in high security installations

FOR MORE INFORMATION

www.milestonesys.com

