

DS7465i



EN | Installation Instructions
Input/Output Module



BOSCH

1.0 Introduction

The DS7465i Input/Output Module operates with compatible multiplex systems. It has a Form “C” relay (the output zone) that is programmed to activate from several different system events. The DS7465i can also monitor normally open (NO) or normally closed (NC) contacts and report their status as a multiplex address to the control system. Up to 60 DS7465i Modules can be used on the DS7400Xi. Use up to 20 DS7465i Modules per bus on compatible fire alarm control panels (FACPs). When installing the DS7465i with a D8125MUX, refer to the *D8125MUX Operation and Installation Guide (P/N: F01U034973)* and the *D9412GV2/D7412GV2 Approved Applications Compliance Guide (P/N: F01U003639)*.

2.0 Installation

These installation instructions assume the control panel is installed and in proper working condition.

Perform the following procedure to install the DS7465i:

 You must program the control panel and set the DS7465i address switches before the DS7465i can operate.

1. Program the DS7465i and the control panel as described in the control panel’s reference guide.

 Disconnect power to the control panel before running wires and connecting the DS7465i.

2. To remove the cover of the DS7465i, place your thumb directly above the lip of the DS7465i and press in and up. Refer to *Figure 1*.

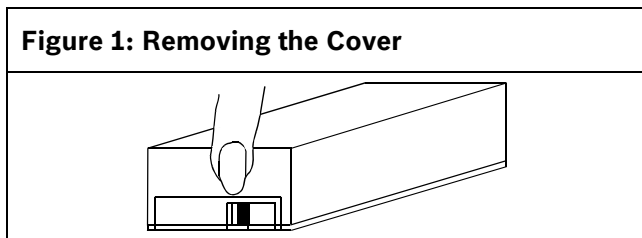

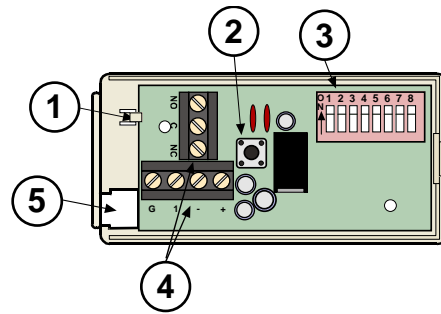

3. To remove the DS7465i circuit board from the base, press the circuit board retainer tab and pull the circuit board up and out of the base. Refer to *Figure 2*.

Figure 2: Removing the Circuit Board



- | | |
|--------------------------------|---------------------|
| 1 - Circuit board retainer tab | 4 - Terminal strips |
| 2 - Tamper switch | 5 - Wire entrance |
| 3 - Address switches | |

 When used in a fire system, NFPA 72 prohibits this product from sharing a communications bus with non-fire devices.

 Hold the circuit board by its edges to avoid damaging it.

4. Insert the wiring through the wire entrance of the base.
5. Mount the base using the supplied screws. Surface-mount the DS7465i near the devices it controls or monitors.
6. Return the DS7465i circuit board to the base.

 After any programming or hardware change, do a functional test of the system as required by local codes.

3.0 Wiring

Table 1: DS7465i Terminal Descriptions



Terminal	Description
NO	Normally open relay contact
C	Common relay contact
NC	Normally closed relay contact
G	Input zone ground
1	Input
-	Multiplex bus negative
+	Multiplex bus positive

 The input zone is power limited and supervised. The output relay must only be used on power-limited circuits.

Fire applications require NO contacts on the input zone.

Connect wiring to the DS7465i as shown in *Figure 3* through *Figure 5*.

 The input loop is designed to monitor NO or NC dry contacts. It is supervised using a 47 kΩ end-of-line (EOL) resistor. If using the input loop as a fire alarm input, order the Multiplex Resistor Kit (P/N: 28010).

Do not loop wire around the terminals.

 The relay contacts are rated 1A @ 30 VDC for resistive loads. Do not use with inductive or capacitive loads.

Figure 3: DS7430 Multiplex Expansion Module Wiring



- 1 - Power
- 2 - Bus
- 3 - To DS7430 Mux Bus Terminals
- 4 - EOL 47 kΩ (P/N 26069)
- 5 - Form "C" dry contacts rated at 1A @ 30 VDC

 For UL Listed fire installations, use NO contacts and order the Multiplex Resistor Kit (P/N: 28010).

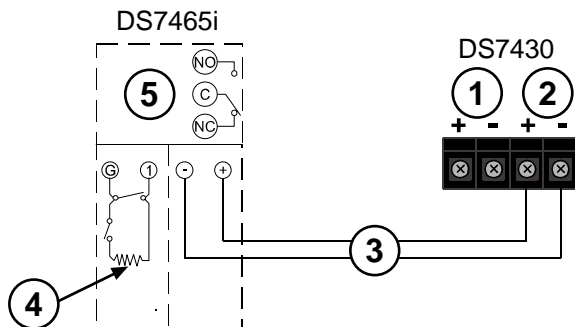
Figure 4: DS7436 Multiplex Expansion Module Wiring



- 1 - Power
- 2 - Bus
- 3 - Use either Bus A or Bus B, or both. Refer to the control panel's reference guide.
- 4 - To DS7436 B+/B- terminals
- 5 - EOL 47 kΩ (P/N 26069)
- 6 - Programmable Form "C" dry contacts rated at 1A @ 30 VDC

 For UL Listed fire installations, use NO contacts and order the Multiplex Resistor Kit (P/N: 28010).

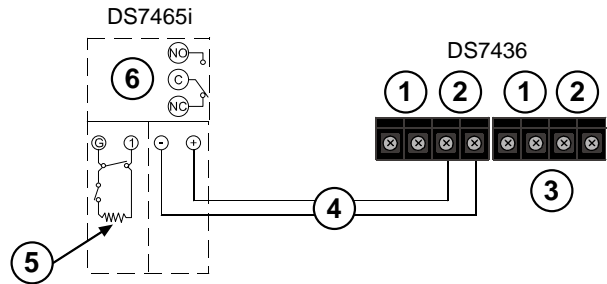
Figure 5: D8125MUX Multiplex Expansion Module Wiring



- 1 - D8125 Multiplex Module
- 2 - Power A
- 3 - MUX Bus A
- 4 - Power B
- 5 - MUX Bus B
- 6 - Use either Bus A or Bus B. Refer to the control panel's reference guide
- 7 - To MUX Expansion Module MUX Bus +/- terminals
- 8 - EOL 47 kΩ (P/N 26069)
- 9 - Form "C" dry contacts rated at 1A @ 30 VDC

4.0 Switch Settings

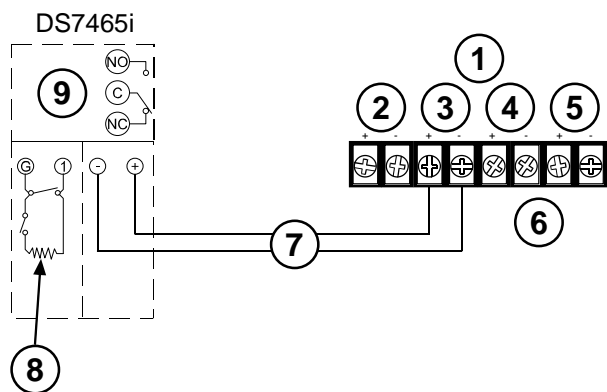
Configure the address switch settings before connecting the DS7465i to the multiplex bus. Refer to *Figure 6*



Do not set any two DS7465i Dual Zone Modules to the same address. Having two or more units set to the same address might prevent fault detection or cause multiplex bus failure.

Figure 6: Address Switches

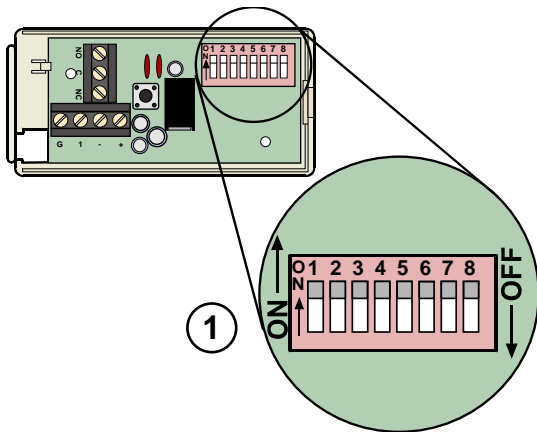

1 - Address switches

You can find the Address Switch Settings using *Table 2* or *Table 3* by calculating the decimal number of the address as shown in *Figure 7*.

Figure 7: Binary Switch Values (Point 17 Shown)

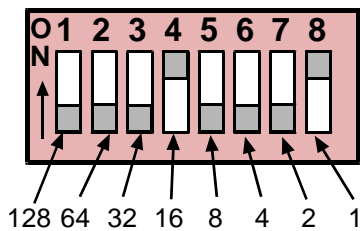

Table 2: DS7465i Switch Settings When Using the DS7430 and DS7436 MUX Expansion Module

Address Zone/Relay	Switch Number (• = ON)							
	1	2	3	4	5	6	7	8
009/010					•			•
011/012					•		•	•
013/014					•	•		•
015/016					•	•	•	•
017/018				•				•
019/020				•			•	•
021/022				•		•		•
023/024				•		•	•	•
025/026				•	•			•
027/028				•	•		•	•
029/030				•	•	•		•
031/032				•	•	•	•	•
033/034			•					•
035/036			•				•	•
037/038			•			•		•
039/040			•			•	•	•
041/042			•		•			•
043/044			•		•		•	•
045/046			•		•	•		•
047/048			•		•	•	•	•
049/050			•	•				•
051/052			•	•			•	•
053/054			•	•		•		•
055/056			•	•		•	•	•
057/058			•	•	•			•
059/060			•	•	•		•	•

Table 2 (Continued)

Address Zone/Relay	Switch Number (• = ON)							
	1	2	3	4	5	6	7	8
061/062			•	•	•	•		•
063/064			•	•	•	•	•	•
065/066		•						•
067/068		•					•	•
069/070		•				•		•
071/072		•				•	•	•
073/074		•			•			•
075/076		•			•		•	•
077/078		•			•	•		•
079/080		•			•	•	•	•
081/082		•		•				•
083/084		•		•			•	•
085/086		•		•		•		•
087/088		•		•		•	•	•
089/090		•		•	•			•
091/092		•		•	•		•	•
093/094		•		•	•	•		•
095/096		•		•	•	•	•	•
097/098		•	•					•
099/100		•	•				•	•
101/102		•	•			•		•
103/104		•	•			•	•	•
105/106		•	•		•			•
107/108		•	•		•		•	•
109/110		•	•		•	•		•
111/112		•	•		•	•	•	•
113/114		•	•	•				•
115/116		•	•	•			•	•
117/118		•	•	•		•		•
119/120		•	•	•		•	•	•
121/122		•	•	•	•			•
123/124		•	•	•	•		•	•

Table 2 (Continued)

Address Zone/Relay	Switch Number (• = ON)							
	1	2	3	4	5	6	7	8
125/126		•	•	•	•	•		•
127/128		•	•	•	•	•	•	•
129/130	•							•
131/132	•						•	•
133/134	•					•		•
135/136	•					•	•	•
137/138	•				•			•
139/140	•				•		•	•
141/142	•				•	•		•
143/144	•				•	•	•	•
145/146	•			•				•
147/148	•			•			•	•
149/150	•			•		•		•
151/152	•			•		•	•	•
153/154	•			•	•			•
155/156	•			•	•		•	•
157/158	•			•	•	•		•
159/160	•			•	•	•	•	•
161/162	•		•					•
163/164	•		•				•	•
165/166	•		•			•		•
167/168	•		•			•	•	•
169/170	•		•		•			•
171/172	•		•		•		•	•
173/174	•		•		•	•		•
175/176	•		•		•	•	•	•
177/178	•		•	•				•
179/180	•		•	•			•	•
181/182	•		•	•		•		•
183/184	•		•	•		•	•	•
185/186	•		•	•	•			•
187/188	•		•	•	•		•	•

Table 2 (Continued)

Address Zone/Relay	Switch Number (• = ON)							
	1	2	3	4	5	6	7	8
189/190	•		•	•	•	•		•
191/192	•		•	•	•	•	•	•
193/194	•	•						•
195/196	•	•					•	•
197/198	•	•				•		•
199/200	•	•				•	•	•
201/202	•	•			•			•
203/204	•	•			•		•	•
205/206	•	•			•	•		•
207/208	•	•			•	•	•	•
209/210	•	•		•				•
211/212	•	•		•			•	•
213/214	•	•		•		•		•
215/216	•	•		•		•	•	•
217/218	•	•		•	•			•
219/220	•	•		•	•		•	•
221/222	•	•		•	•	•		•
223/224	•	•		•	•	•	•	•
225/226	•	•	•					•
227/228	•	•	•				•	•
229/230	•	•	•			•		•
231/232	•	•	•			•	•	•
233/234	•	•	•		•			•
235/236	•	•	•		•		•	•
237/238	•	•	•		•	•		•
239/240	•	•	•		•	•	•	•
241/242	•	•	•	•				•
243/244	•	•	•	•			•	•
245/246	•	•	•	•		•		•
247/248	•	•	•	•		•	•	•
249/250	•	•	•	•	•			•
251/252	•	•	•	•	•		•	•

Table 2 (Continued)

Address Zone/Relay	Switch Number (• = ON)							
	1	2	3	4	5	6	7	8
253/254	•	•	•	•	•	•		•
255/256	•	•	•	•	•	•	•	•

Table 3: DS7465i Switch Settings When Using a D8125MUX Expansion Module on ZONEX Bus 1 (D9412G, D9112, D7412G, and D7212G)

Point (Relay) Address	Switch Number (• = ON)							
	1	2	3	4	5	6	7	8
009					•			•
010					•		•	
011					•		•	•
012					•	•		
013					•	•		•
014					•	•	•	
015					•	•	•	•
016				•				
017				•				•
018				•			•	
019				•			•	•
020				•		•		
021				•		•		•
022				•		•	•	
023				•		•	•	•
024				•	•			
025				•	•			•
026				•	•		•	
027				•	•		•	•
028				•	•	•		

Note: Only Addresses 009 through 064 support the relay option.

Table 3 (Continued)

Point (Relay) Address	Switch Number (• = ON)							
	1	2	3	4	5	6	7	8
029				•	•	•		•
030				•	•	•	•	
031				•	•	•	•	•
032			•					
033			•					•
034			•				•	
035			•				•	•
036			•			•		
037			•			•		•
038			•			•	•	
039			•			•	•	•
040			•		•			
Maximum Number of Points (D7212G)								
041			•		•			•
042			•		•		•	
043			•		•		•	•
044			•		•	•		
045			•		•	•		•
046			•		•	•	•	
047			•		•	•	•	•
048			•	•				
049			•	•				•
050			•	•			•	
051			•	•			•	•
052			•	•		•		
053			•	•		•		•
054			•	•		•	•	
055			•	•		•	•	•
056			•	•	•			
057			•	•	•			•
058			•	•	•		•	

Note: Only Addresses 009 through 064 support the relay option.

Table 3 (Continued)

Point (Relay) Address	Switch Number (• = ON)							
	1	2	3	4	5	6	7	8
059			•	•	•		•	•
060			•	•	•	•		
061			•	•	•	•		•
062			•	•	•	•	•	
063			•	•	•	•	•	•
064		•						

Note: Only Addresses 009 through 064 support the relay option.

5.0 Specifications

5.1 Module Compatibility

The DS7465i works with the following multiplex expansion modules:

- DS7430
- DS7436
- D8125MUX (refer to the *D8125MUX Operation and Installation Guide* (P/N: F01U034973)).

5.2 Wiring Requirements

Table 4: Specifications

Current Draw	1 mA maximum	
Operating Temperature	+32° to +122°F (0° to +50°C)	
Relative Humidity	0 to 93%	
Line Impedance	Maximum Impedance: 4.05Ω at +68°F (+20°C) nominal	
	Maximum Distance	Size
	200 ft	22 AWG
	600 ft	18 AWG
	76 m	0.65 mm
	193 m	1.02 mm
	Fire applications require 18 AWG.	
Relay Contact Rating	1A @ 30 VDC resistive	
Signaling Line Circuit Type	Class B (Style 4)	
Initiating Line Circuit Type	Class B (Style A)	

Bosch Security Systems, Inc.
130 Perinton Parkway
Fairport, NY 14450-9199
(800) 289-0096

© 2008 Bosch Security Systems, Inc.
F01U070743-03



BOSCH